

Article number: 20274B48MZ2SW

Description: E+G Swivel clamp connector
GN274-B48-MZ-2-SW

Measures

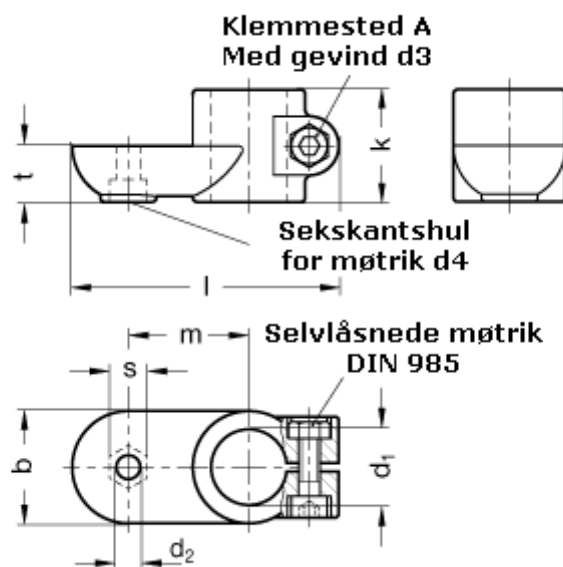

b = 65	s = 17
d1 = B48	t = 32.5
d2 = 10.5	
d3 = M10	
d4 = M10	
k = 65	
l = 148	
m = 70	